

saxun[®]

SOLAR PROTECTION SYSTEMS



Official UK Partner

saxun[®]

SOLAR PROTECTION SYSTEMS

Dear customer,

Welcome to Saxun by Soller.

In the following pages, we present a refined collection of solar protection systems developed by Saxun and introduced to the UK in partnership with Soller.

This is a proposal inspired by the Mediterranean way of living: elegant shade, visual comfort, cleaner design and outdoor spaces that feel calm, usable and complete.

It is a feeling many people already recognise from time spent abroad.

- A beautifully shaded terrace.
- A more comfortable patio.
- Longer evenings outside.

Now, through Saxun by Soller, that same atmosphere can be created at home with solutions tailored for British properties and projects.

Go ahead, rediscover outdoor living.





saxun®



Aneas 125x125

INTEGRAL PROTECTION TAILOR MADE FOR EVERY PROJECT



Saxun is Giménez Ganga's star company, dedicated to the manufacture and distribution of solar protection systems.

Thanks to the widest possible selection of technical curtains, awnings, parasols and pergolas, we have achieved to be present in over 70 countries on all five continents.

The work of our team, focused on meeting the needs of each user, is based on the philosophy of developing alongside those who matter most to us: our customers.

MULTIPLE SOLUTIONS

The wide selection of systems, fabrics, colours and accessories from which the user can choose makes it easy to integrate Saxun products into any type of space.

Our large collection of solar protection systems can be adapted to all types of terraces, balconies and windows, both in homes and in hotel and restaurant businesses.

WELL-BEING AND FUNCTIONALITY

The combination of the most innovative systems, together with the most cutting-edge technology and a wide variety of intelligent drives, ensures that there will always be a Saxun solution with a high degree of customization.

THE GUARANTEE OF THE BEST MATERIALS

The use of premium materials such as aluminium or technical fabrics used in our systems ensures a long life for all Saxun products.

SERVICE OF A LEADING BRAND

A high quality product, together with advice from our qualified professionals, ensures that the Saxun option chosen fits perfectly on a technical and aesthetic level with the space to be protected.



MAXIMUM COMFORT IN HOTELS AND RESTAURANTS

With Saxun, hotels and restaurants will get that extra bit of comfort that makes all the difference at a time like the present, when users are looking to make every stay an unforgettable experience.

Thanks to our solar protection systems, each company will find a solution tailored to the needs of its space.

A cost-effective solution right from the moment of installation.



WE CONVERT HOUSES INTO HOMES

Maintaining a pleasant temperature all year round, protecting spaces from the visual discomfort generated by the sun's rays and changing the decoration in search of a new touch to the home are just some of the benefits that can be obtained by those who choose Saxun for their homes.

In addition, the use of the latest home automation technology will allow total control over the operation of the different solar protection systems incorporated into the home. From anywhere. At any time.

LA SOMBRA DE BERASATEGUI: A SERIES IN WHICH SOLAR PROTECTION IS KEY

Martín, the key personality of the series, has been chosen by Saxun as a consultant for the development and adaptation of the firm's solar protection systems for hotel and catering projects.



A cast to match that of Saxun

Other renowned chefs such as David de Jorge, highly valued food critics such as Mikel Iturriaga or experienced journalists such as Adela Úcar make up a luxury line-up that is sure to hook anyone who decides to watch the series.



LaSombradeBerasategui.com is a web space where this initial audiovisual series about our most widely recognised chef may be enjoyed.

The series consists of five chapters in which an analysis of the needs of a key sector of the social and economic structure of Spain is carried out, based on the experience of the renowned chef.

Our solar protection systems serve as a constant backdrop as Martín uncovers the secrets that have led him to become a leading international figure in the oven market.

Index

01

BOXES

- Kiara . *p. 14*
- Slavia . *p. 16*
- Elba . *p. 16*
- Aida . *p. 18*
- Ameris . *p. 18*
- Palas . *p. 19*

02

EXTENDIBLE ARMS

- Orus I . *p. 22*
- Orus II . *p. 22*
- Aura . *p. 23*
- Herta . *p. 23*

03

MONOBLOCK EXTENDIBLE ARMS

- Zeres I . *p. 25*
- Zeres II . *p. 25*

07

STOR AWNING

- Themis . *p. 36*
- Hybris . *p. 36*

08

SRS

- SRS . *p. 38*

09

PERGOLA WITH TENSIONATED CANVAS

- Fulvia . *p. 40*

"It's not just about foreseeing the future, it's about making it possible."

— *Antoine de Saint-Exupéry*

04

FLAT AWNING

Aneas 80x80 . p. 28

Aneas 80x40 . p. 30

Aneas 125x125 . p. 30

05

DROP AWNINGS

Eros Blind . p. 32

Eros Spire . p. 32

Eros Lens . p. 32

06

STRAIGHT TENSION POINT

Metis . p. 34

Heber . p. 34

10

VERANDA

Jana . p. 45

Lina . p. 45

11

CURTAIN

Martha . p. 47

Strada . p. 47

12

CAPOTA

Lutecia . p. 48



Kiara



01

BOXES

Saxun box awnings are the most advanced solutions in a market that is constantly evolving.

These systems are developed using the latest technology to house the awning mechanism inside and protect it from all types of weather.

The variety of options and sizes in our catalogue favours the existence of an option suited to each need. At any longitude and latitude.

The simplicity of anchoring the structure to the façade, and the possibility of motorisation and automation of the system, make Saxun box awnings the favourite choice of professionals and users.



Kiara

PROTECTION FOR THE FAÇADES OF TOMORROW

■ KIARA

Kiara is the new box awning developed by Saxun.

A solar protection system with an attractive aesthetic that combines practical and advanced features so it can be installed quickly and easily.

Its 100% metallic structure gives it a colour that is uniform and sophisticated, as there are no plastic elements to compromise its chromatic uniformity.

These sensations don't stop when the sun goes down, as we offer the potential for LED lighting both in the arms and in the box itself.

As such, you will be able to enjoy an unforgettable sunset every day in the best of company.



max.

MAXIMUM DIMENSIONS	
Maximum clearance	4.00 m
Maximum line	6.00 m

A

INCLINATION DEGREES	
Frontal installation	0° to 75°
Roof installation with panel	17° to 75°
Roof installation with bracket	0° to 75°
Installation between walls	0° to 75°

⚡

MAXIMUM RESISTANCE TO WIND	
<i>EN13561 Standard</i>	
CLASS 2	6.00x2.75 m
CLASS 2	5.00x3.50 m

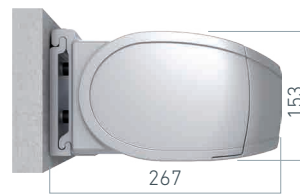

Front

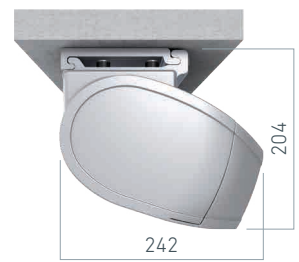

Roof

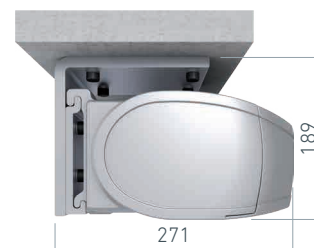

Roof with bracket

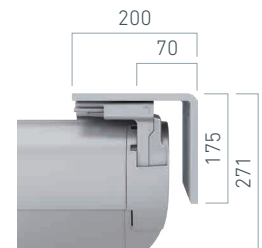

Between walls

SLAVIA

- Inclusion of a highly resistant articulated arm.
- Concealment of the fastening components for a better aesthetic appearance.
- Compact awning that integrates perfectly into the space.



MAXIMUM DIMENSIONS

Maximum clearance	2.50 m
Maximum line	5.00 m



INCLINATION DEGREES

Frontal installation	0° to 69°
Ceiling installation	0° to 69°



MAXIMUM RESISTANCE TO WIND

EN13561 Standard

CLASS 3	5.00x1.50 m
CLASS 2	4.00x2.50 m

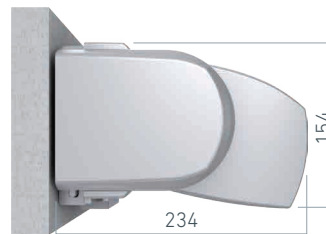
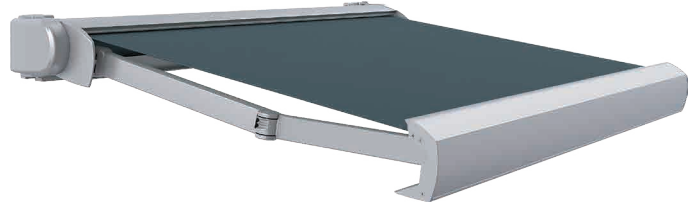

Wall

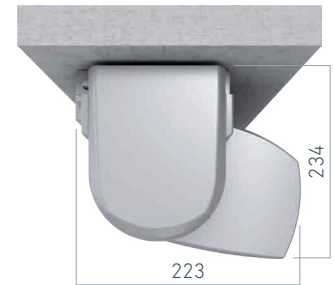

Roof

ELBA

- Manufactured entirely from aluminium to guarantee chromatic uniformity.
- Concealment of mechanical elements for better aesthetics.
- Ideal for protecting large surface areas.
- LED lighting in arms.



MAXIMUM DIMENSIONS

Maximum clearance	3.50 m
Maximum line	6.00 m



INCLINATION DEGREES

Frontal installation	0° to 72°
Roof installation with panel	0° to 78.50°



MAXIMUM RESISTANCE TO WIND

EN13561 Standard

CLASS 3	6.00x3.00 m
---------	-------------

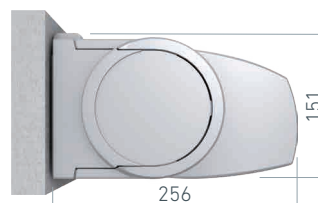

Wall

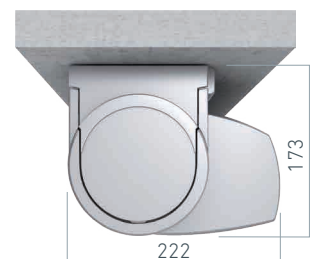

Roof



Elba

AIDA

- Easy installation directly in front.
- Option of ceiling installation with additional supports.
- It can be produced with two different colours on the front profile and the box.
- LED lighting in arms.



MAXIMUM DIMENSIONS

Maximum clearance	3.60 m
Maximum line	6.00 m



INCLINATION DEGREES

Front and ceiling installation	0° to 40°
--------------------------------	-----------



MAXIMUM RESISTANCE TO WIND

<i>EN13561 Standard</i>	
CLASS 2	6.00x 3.60 m

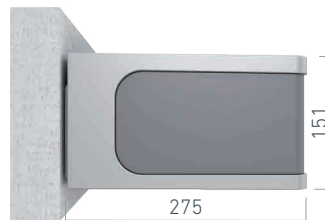
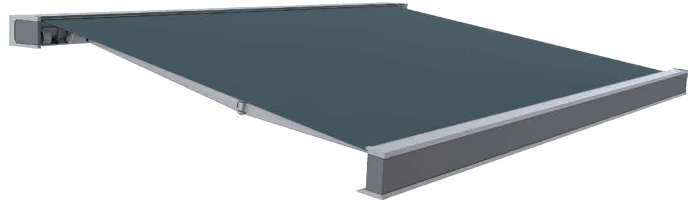

Front

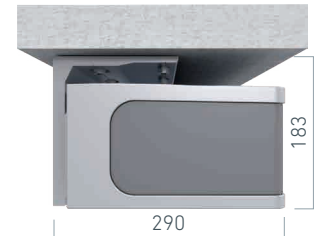

Roof

AMERIS

- Wide variety of lacquers available.
- May be manufactured with large dimensions.
- All screws and fasteners may be concealed.
- Option to include LED lighting in arms.



MAXIMUM DIMENSIONS

Maximum clearance	4.10 m
Maximum line	6.00 m



INCLINATION DEGREES

Front and ceiling installation	0° to 40°
--------------------------------	-----------



MAXIMUM RESISTANCE TO WIND

<i>EN13561 Standard</i>	
CLASS 1	6.00x4.10 m

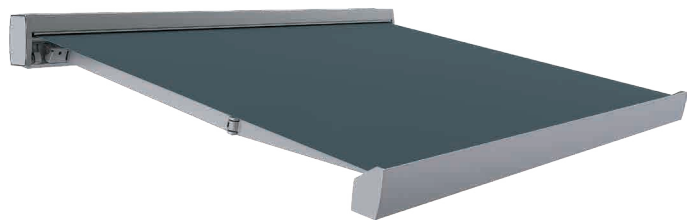

Front

PALAS

- Possibility of moving the arms over the line.
- Possibility of increasing the maximum line by installing a third arm.
- Allows the installation of more anchorage supports.
- LED lighting in arms.



MAXIMUM DIMENSIONS

Maximum clearance	3.60 m
Maximum line 2 arms	6.00 m
Maximum line 3 arms	7.00 m



INCLINATION DEGREES

Front and ceiling installation 0° to 40°



MAXIMUM RESISTANCE TO WIND

EN13561 Standard

CLASS 2 7.00 x 3.60 m

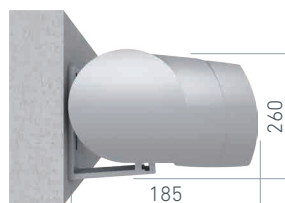
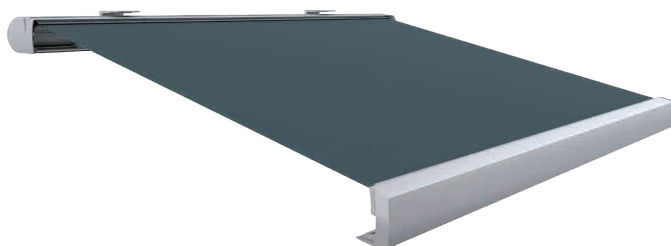

Front

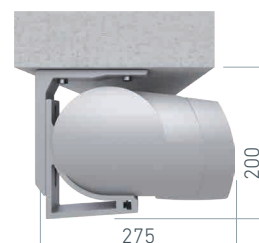

Roof



Aida

02

EXTENDIBLE ARMS

100% motorised system based on two extendable arms that are hidden under the canvas allowing perfect mobility in the environment where it is installed.

As it does not need metal structures to support the awning, it can be easily adapted to all kinds of needs.

Designed for balconies and terraces, it has half-box versions for greater protection of the fabric.



Herta



ORUS I

- Greater durability and resistance thanks to the division of its arms.
- Manufactured entirely from aluminium.
- Option to include LED lighting in arms.

	MAXIMUM DIMENSIONS	
	Maximum clearance	3.50 m
	Maximum line	6.00 m

	INCLINATION DEGREES	
	Front and ceiling installation	0° to 85°

	MAXIMUM RESISTANCE TO WIND	
	<i>EN13561 Standard</i>	
	CLASS 2	6.00x3.00 m
	CLASS 2	5.00x3.50 m

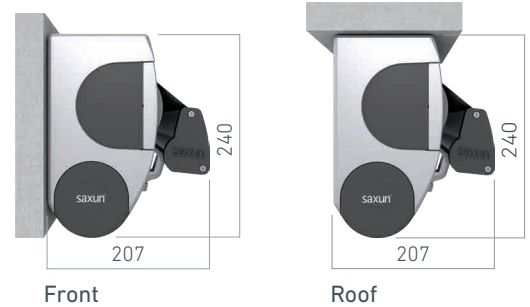

ORUS II

- Greater durability and resistance thanks to the division of its arms.
- Crossed-arm system for optimal clearance in spaces where a broad line is not possible.
- Option to include LED lighting in arms.

	MAXIMUM DIMENSIONS	
	Maximum clearance	3.00 m
	Maximum line	3.50 m

	INCLINATION DEGREES	
	Front and ceiling installation	0° to 30°

	MAXIMUM RESISTANCE TO WIND	
	<i>EN13561 Standard</i>	
	CLASS 2	3.50 x 3.00 m

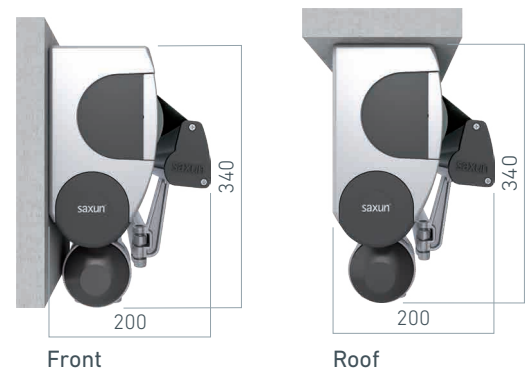

AURA

- **Greater durability and resistance** thanks to the division of its arms.
- Independent lateral support systems for the integration support and extension arm.
- Easy integration thanks to its compact size.



MAXIMUM DIMENSIONS

Maximum clearance	2.50 m
Maximum line	4.00 m



INCLINATION DEGREES

Front and ceiling installation	0° to 90°
--------------------------------	-----------



MAXIMUM RESISTANCE TO WIND

EN13561 Standard

CLASS 2	4.00 x 2.50 m
---------	---------------

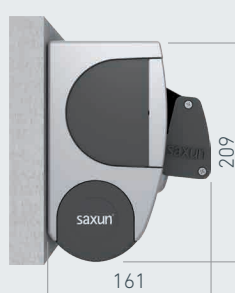

Front

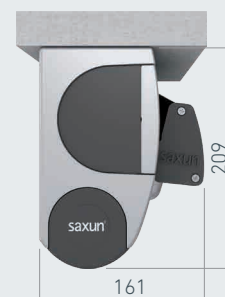

Roof

HERTA

- Manual operation without the need for wiring.
- The double system is easy to use, as the fabric is rolled on the same axis.
- Optimal anchorage with the structure supported through a fixed base.
- Option to include LED lighting in arms.



MAXIMUM DIMENSIONS

Maximum clearance	3.00 m
Maximum line	6.00 m



INCLINATION DEGREES

Front and ceiling installation	5° to 20°
--------------------------------	-----------

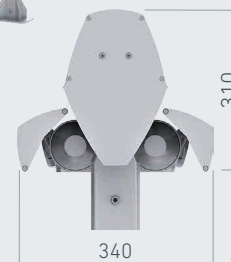

Roof



Zeres I

03

EXTENDIBLE ARMS MONOBLOCK

The awning has great resistance and coverage capacity, making it possible to regulate and position the arms prior to installation, reducing the awning assembly time during work projects.

The supports, mounted on a 40x40 mm square bar, allow the arms to be easily moved to the desired distance and two or more arms to be coupled to the structure.

It also makes it possible to incorporate a half-box to ensure greater protection of the fabric when the awning is retracted.

ZERES I

- Greater durability and resistance thanks to the division of its arms.
- Incorporation of several supports to optimise the anchorage.
- Separation of support brackets from the articulating arm
- Option to include LED lighting in arms.



MAXIMUM DIMENSIONS

Maximum clearance	3.50 m
Maximum line	6.00 m



INCLINATION DEGREES

Front and ceiling installation	0° to 85°
--------------------------------	-----------



MAXIMUM RESISTANCE TO WIND

EN13561 Standard

CLASS 3	6.00 x 3.00 m
CLASS 2	5.25 x 3.50 m

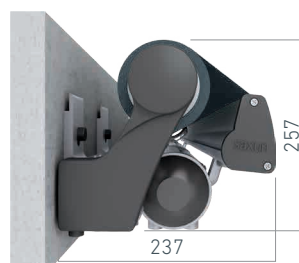

Front

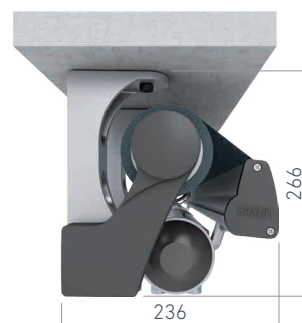

Roof

ZERES II

- Incorporation of several supports to optimise the anchorage.
- Separation of support brackets from the articulated arm.
- Crossed arm systems to optimise clearance in spaces that do not allow a wide line.
- Option to include LED lighting in arms.



MAXIMUM DIMENSIONS

Maximum clearance	3.00 m
Maximum line	3.50 m



INCLINATION DEGREES

Front and ceiling installation	0° to 30°
--------------------------------	-----------



MAXIMUM RESISTANCE TO WIND

EN13561 Standard

CLASS 2	3.50 x 3.00 m
---------	---------------

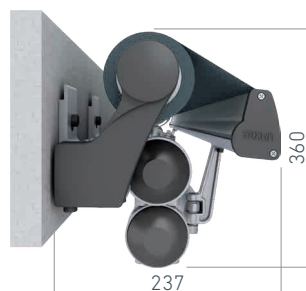

Front



Roof



Aneas 80x40



04



FLAT AWNING

Structures with pure lines where the canvas forms waves and creates clear and ordered spaces that bring balance, harmony and design to the space.

Hidden fittings give the product a 'clean' image and are more resistant to exposure to the elements.

The wide variety of mounting accessories it incorporates satisfies the needs of all types of installers.

In addition, it allows large dimensions in a single piece, making it possible to assemble several structures to achieve greater coverage of surfaces.

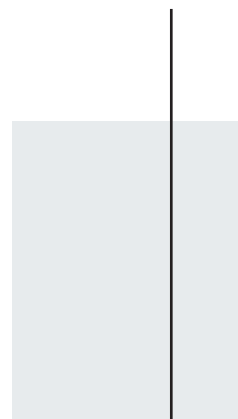



TRADITIONAL PROTECTION THAT'S HIGHLY EFFECTIVE

■ ANEAS 80x80

Aneas 80x80 is a new and optimised flat awning system ideal for all types of terraces and existing structures in houses and businesses.

Designed with 80x80 profiles, its installation can be done through its self-supporting structure or with a façade or slab support.

The many possibilities for manual, automated or smart installation and operation make life easier for installers, workers and users.

The flat awning of this new Saxun system has built in LED lighting. In this way, you can ensure enjoyment of the space in an atmosphere of total comfort when night falls.

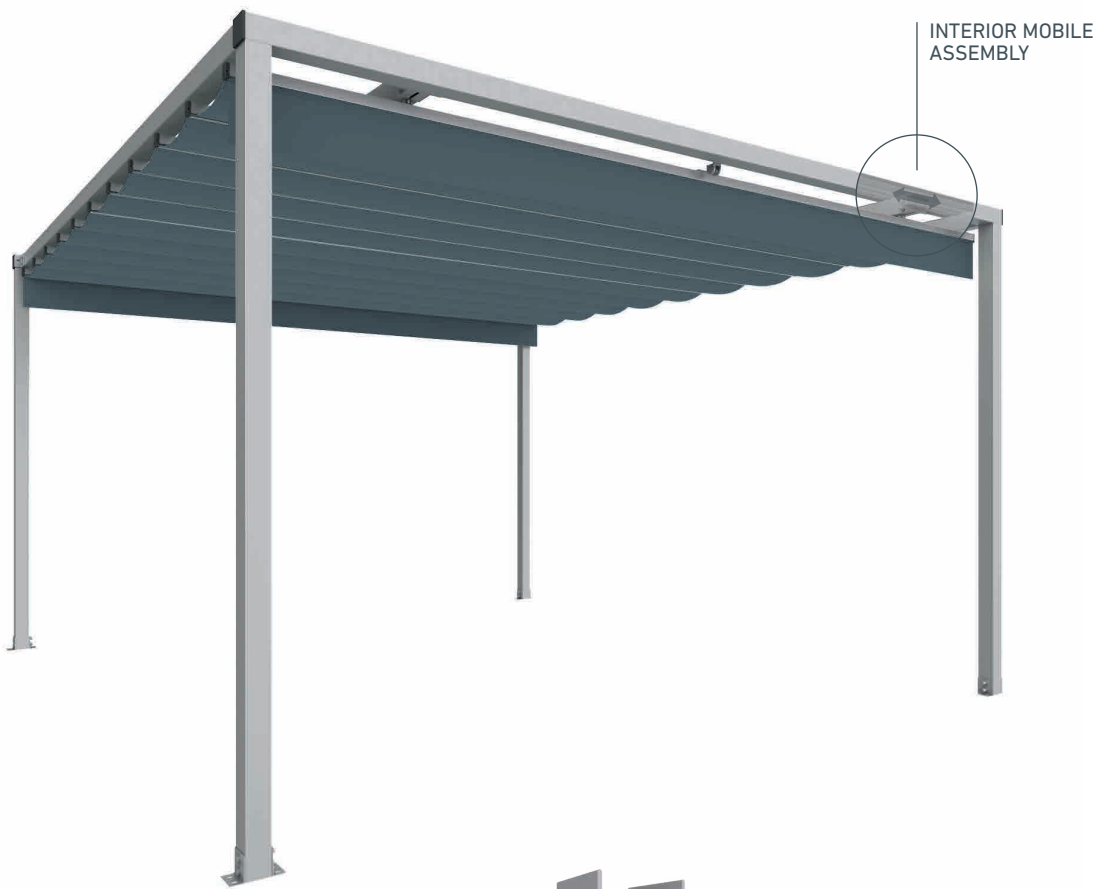

MAXIMUM DIMENSIONS

Maximum clearance	7.00 m
Maximum line	7.00 m



Floor



Interior mobile assembly
Wall | Floor (support only)



MAXIMUM RESISTANCE TO WIND

EN13561 Standard

CLASS 3	5.00x5.00 m
CLASS 2	7.00x5.00 m

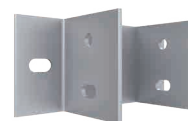

Wall



Structural profile joint

ANEAS 80x40

- Compact size, highly recommended for distinguished spaces.
- Ideal for wall installation.
- Downs pout awnings may be installed in the beam version.
- Its sticks allow the inclusion of LED lighting.



MAXIMUM DIMENSIONS

Maximum clearance 7.00 m
Maximum line 7.00 m



MAXIMUM RESISTANCE TO WIND

EN13561 Standard

CLASS 3 5.00x5.00 m
CLASS 2 7.00x5.00 m



Wall



Floor

ANEAS 125x125

- Large structure size especially suitable for spaces that require maximum performance.
- Downs pout awnings may be installed in the beam version.
- Maximum resistance to wind and weather.
- Its sticks allow the inclusion of LED lighting.



MAXIMUM DIMENSIONS

Maximum clearance 7.00 m
Maximum line 7.00 m



MAXIMUM RESISTANCE TO WIND

EN13561 Standard

CLASS 3 7.00x7.00 m



Wall



Floor

CONFIGURATIONS

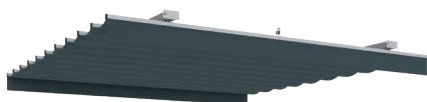

- BETWEEN WALLS

The **ideal option for patios or gardens** that have mounting bases as walls, facilitating creation of integrated and balanced environments.

It comprises longitudinal profiles attached to the fixing support and other transversal profiles that join both sides.



- FRAME CROSSBEAMS

This system can be adapted to **all types of open spaces** such as terraces or patios.

The incorporation of crossbeams adds great stability to the structure, and makes it possible to install '*Made in Saxun*' solutions such as **Eros** or **Wind Screen**.

When the double crossbeam option is selected, it becomes a self-supporting system.



- FREE-STANDING FRAME

This product is similar to the crossbeam frame, but with a fundamental aesthetic difference: it does not have side beams.

It is characterised by the purity of its lines and integrates perfectly into **all types of spaces** where there is a need for protection.

It accepts the double frame option.



Eros Blind

05



DROP AWNINGS

Designed to provide vertical shade, it protects spaces from the horizontal rays that are typical of the early morning and evening.

Its function is to close structures laterally, via the vertical movement of a canvas that can slide through extruded aluminum guides.

The option of configuration via guides allows the awning to present optimal wind resistance, and perfect integration between the awning and the façade.



EROS

- Made of acrylic canvas, PVC and stabilised glass.
- Two glass finish options: smooth or striped.
- The system can be fixed to the floor by means of hinged straps and rings.



MAXIMUM DIMENSIONS

Maximum height 5.00 m
Maximum width 3.25 m



MAXIMUM RESISTANCE TO WIND

EN13561 Standard
CLASS 2 5.00x2.50 m

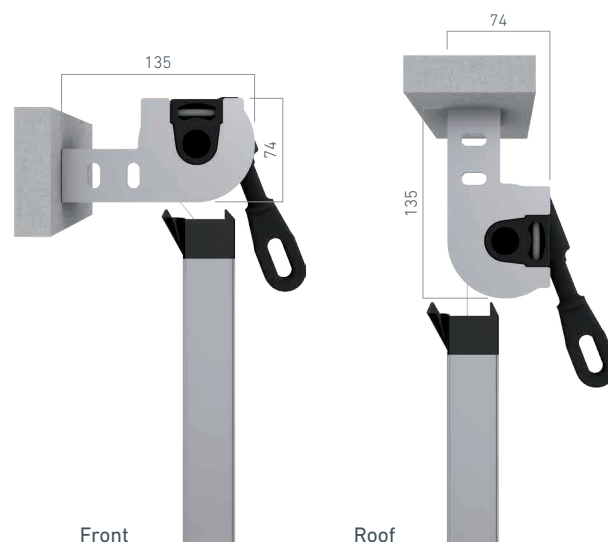

EROS BLIND

This system is designed to add space to an area while protecting your privacy.



EROS SPIRE

A high-security system: in the event of strong winds, the canvas leaves the guides to avoid wind damage.

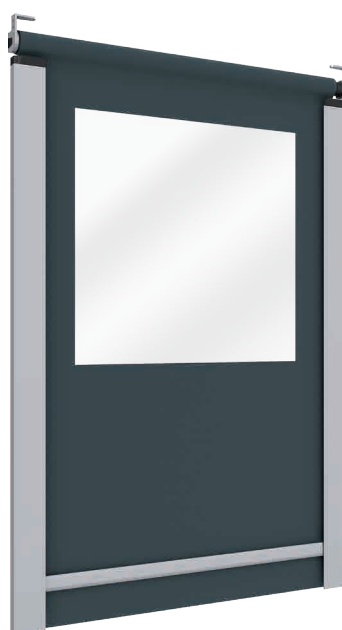

EROS LENS

A high-stability system. The inclusion of aluminium crossbars guarantees maximum resistance to wind and rain.

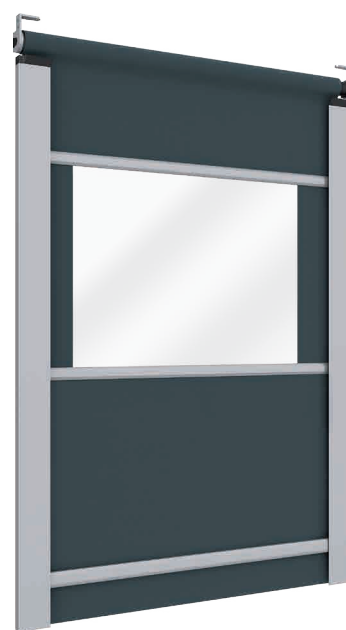

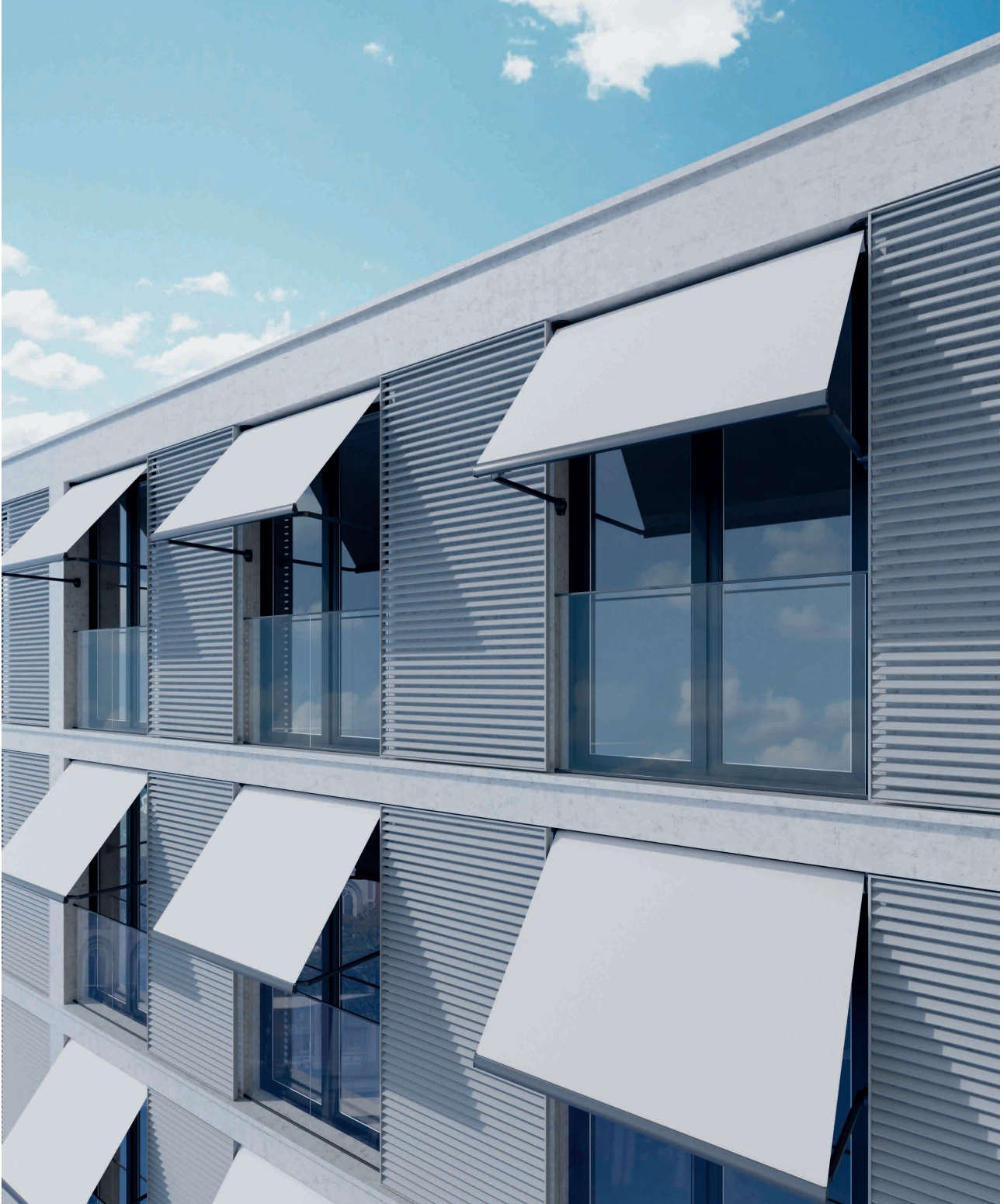

Themis

06



STRAIGHT TENSION POINT

A more traditional awning system, characterised by the frontal folding of the arms.

It works perfectly when not much arm movement is required, protecting users from the oblique sun rays that are common during long summer evenings.

METIS

- Constant tension of the canvas.
- Optional ceiling or wall mounting, ideal for window installation.
- Fully vertical coverage.

	MAXIMUM DIMENSIONS	
	Maximum clearance	1.50 m
	Maximum line	6.00 m

	INCLINATION DEGREES	
	Frontal installation	0° to 170°

	MAXIMUM RESISTANCE TO WIND	
	EN13561 Standard	
	CLASS 3	6.00x1.50 m

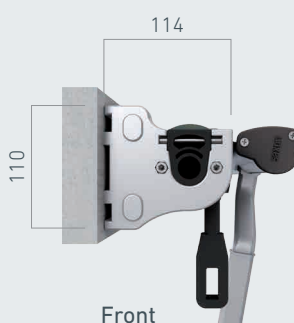

HEBER

- Options for height and inclination adjustment, providing protection and ventilation.
- Optional wall and ceiling mounting.
- Ideal for installation in windows.

	MAXIMUM DIMENSIONS	
	Maximum clearance	1.50 m
	Maximum line	5.00 m

	INCLINATION DEGREES	
	Frontal installation	0° to 170°

	MAXIMUM RESISTANCE TO WIND	
	EN13561 Standard	
	CLASS 3	5.00x1.50 m



07



STOR AWNING

Easy to install vertical awnings that adapt to the shape of the window to block annoying horizontal sun rays.

Easy to install and adapt to any façade, they offer great resistance to wind and weather.



Hybris

THEMIS

- May be installed on a balcony.
- Choice of front or ceiling mounting.
- Compatible with motorisation and automation systems.



MAXIMUM DIMENSIONS

Maximum clearance 2.50 m
Maximum line 6.00 m



INCLINATION DEGREES

Frontal installation 0° to 170°



MAXIMUM RESISTANCE TO WIND

EN13561 Standard

CLASS 3 6.00x1.50 m

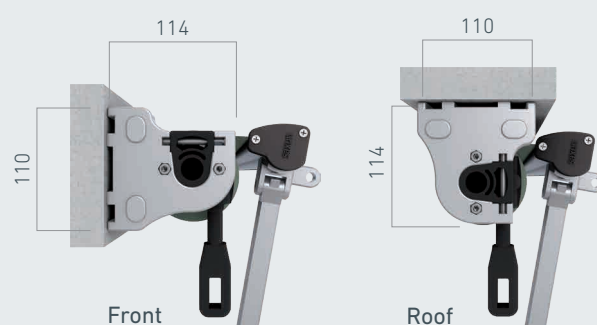

HYBRIS

- The canvas is vertical and allows you to specify a height from which to lower the arm, at an inclination.
- Easy installation on ceilings or walls.



MAXIMUM DIMENSIONS

Maximum clearance 3.00 m
Maximum line 4.00 m



INCLINATION DEGREES

Frontal installation 0° to 170°



MAXIMUM RESISTANCE TO WIND

EN13561 Standard

CLASS 3 4.00x3.00 m

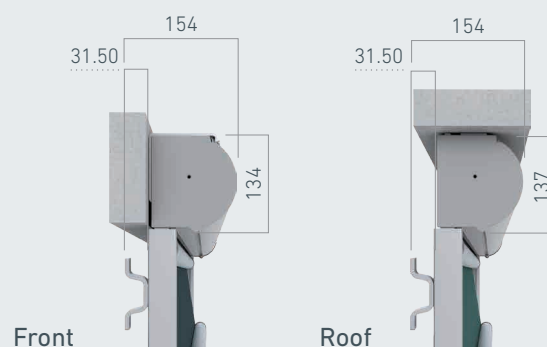

08



SRS

An outdoor system with multiple installation options that addresses a wide range of requirements both for the housing sector and for industrial and service uses.

Its avant-garde design and the versatility provided by the wide range of fabrics, colours and finishes to choose from are sure to satisfy the requirements of each space.



SRS

SRS

- Total protection of the canvas, thanks to the effectiveness of its box.
- Canvas guidance via steel cables.
- Easy installation on ceilings or walls.

MAXIMUM DIMENSIONS
 max. Maximum height 3.40 m
 Maximum width 4.00 m

MAXIMUM RESISTANCE TO WIND
 EN13561 Standard
 CLASS 3 4.00x3.40 m

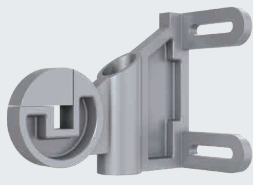

Front



Floor



FRONT ATTACHMENT | FRONT

Measurements in mm.

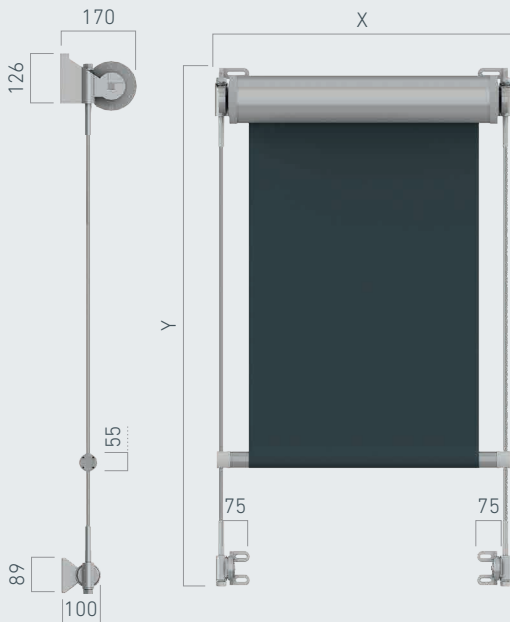

ROOF SUPPORT | SOIL

Measurements in mm.

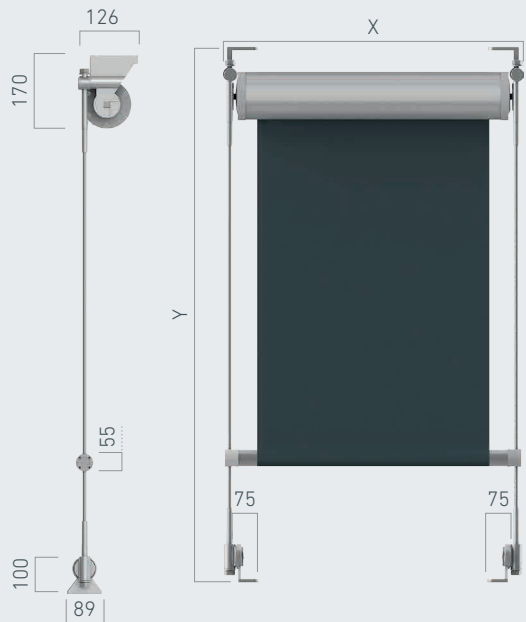



Fulvia



09



PERGOLA WITH TENSIONATED CANVAS

Saxun's Fulvia taut canvas pergola is a solar protection system specially designed to protect from sun and rain all year round.

Its modular and dynamic design of straight lines allows its adaptation to all types of gardens and terraces, while multiplying the possibilities of these spaces, giving them elegance and comfort.

It incorporates an extensible and waterproof taut canvas, automatically activated by remote control. When tensioned, it facilitates the evacuation of water through its columns.



DESIGNED FOR YOUR ENJOYMENT - ALL YEAR ROUND

■ FULVIA

The product allows longitudinal LED lighting to be incorporated into the mobile crossbeams, as well as into the gutter and fixed crossbeams, with all wiring concealed; furthermore, the light intensity can be adjusted at any time.

With the Fulvia system, the user has the ability to select two lighting scenarios: one with the pergola retracted and another with the pergola extended, thus

allowing the maximum enjoyment of the long summer nights on the terrace.

In addition, the system is 100% compatible with Saxun's most popular locking systems: the Eros and Wind Screen ranges. In this way, the living space of your home or business can be extended, allowing the terrace to stay open 365 days a year.

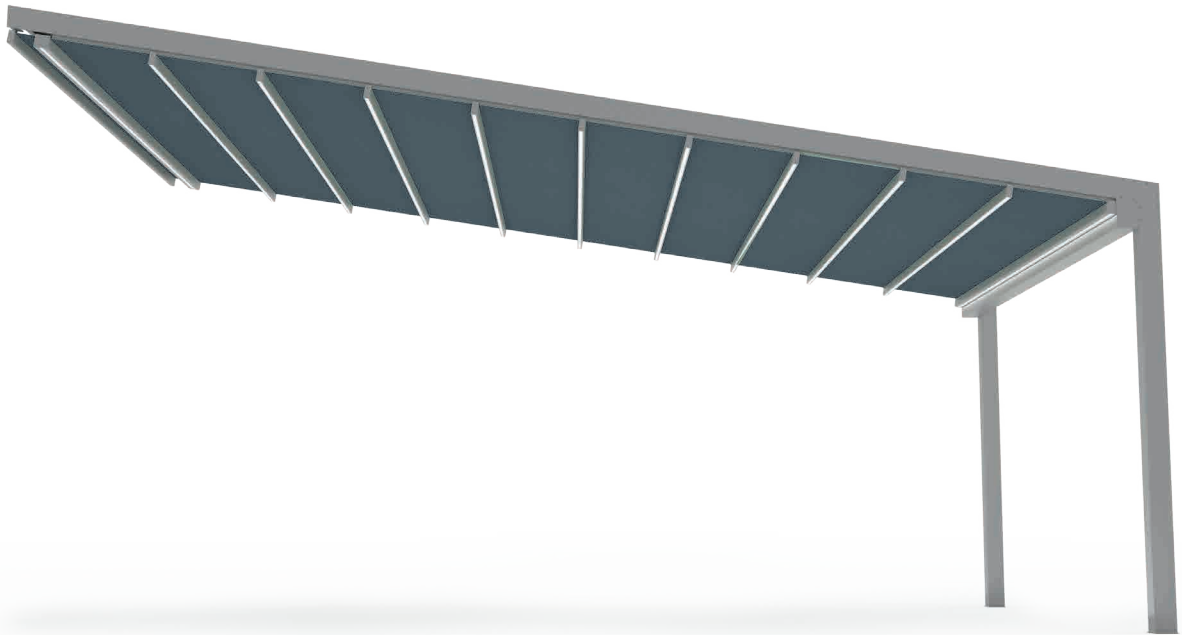

MAXIMUM DIMENSIONS

1 Module	5.00x6.50x3.00 m
2 Modules	9.00x6.50x3.00 m
3 Modules	13.00x6.50x3.00 m



MAXIMUM RESISTANCE TO WIND

EN13561 Standard

CLASS 3 13.00x6.50x3.00 m

MODULARITY



1 Module

2 Modules



3 Modules

10



VERANDA

Our motorised, guide-driven taut canvas systems are designed to protect terraces from direct sunlight.

The nature of the structure, manufactured with an optimal inclination, assists drainage when even the lightest rains arrive.



Jana

JANA

- The canvas may be changed without dismantling the guides or removing the box.
- Minimum required canvas inclination: 15°.



MAXIMUM DIMENSIONS

Maximum clearance	5.00 m
Maximum line	5.00 m



MAXIMUM RESISTANCE TO WIND

EN13561 Standard

CLASS 2 5.00x5.00 m



LINA

- Easy lateral drainage, with the canvas installed outside the guides.
- The built-in central guide for joining two awnings facilitates the production of larger widths.



MAXIMUM DIMENSIONS

Maximum clearance	4.00 m
Maximum line	5.00 m



MAXIMUM RESISTANCE TO WIND

EN13561 Standard

CLASS 1 5.00x4.00 m



11

CURTAIN

Thanks to these systems, the designer can effectively separate spaces, ensuring the privacy of users and turning static places into modular ones. It is ideal for businesses due to the durability of its components.



Martha

MARTHA

- The highly durable components can resist adverse weather conditions.
- Easy integration into even the most demanding projects.
- Easy adaptation to any space thanks to its maximum height.



MAXIMUM DIMENSIONS

Maximum height 2.50 m
Maximum width 3.00 m



MAXIMUM RESISTANCE TO WIND

EN13561 Standard

CLASS 1 2.50 x 3.00 m

ENCLOSED SYSTEM

Measurements in mm.

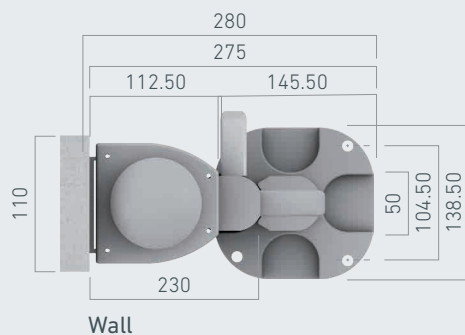

STRADA

- The highly durable components can resist adverse weather conditions.
- Easy integration into even the most demanding projects.
- Wide variety of colours to adapt to all types of decorations.



MAXIMUM DIMENSIONS

Maximum height 4.00 m
Maximum width 7.00 m



RAIL | PULLEY

Measurements in mm.

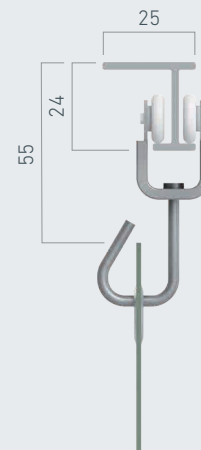



Lutecia

12

CANOPY

The canopy awning is the classic model for window and shop window protection. It is an elegant and timeless model that integrates with those more traditional façades.

With options for fixed or folding installations, it can be adapted to the lighting and aesthetic requirements of each type of user.

LUTECIA

- Circular shape with 90° radii and angles.
- Easy operation by means of a pulley system and a rope pull.
- Lateral coverage for doors and windows.

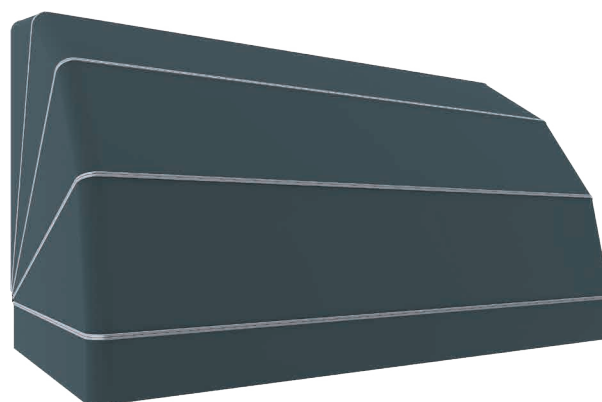

MAXIMUM DIMENSIONS 4 ARCHES

Maximum height	1.20 m
Maximum width	2.50 m



MAXIMUM DIMENSIONS 5 ARCHES

Maximum height	1.20 m
Maximum width	3.00 m

AVAILABLE CONFIGURATIONS

4 and 5 arches.

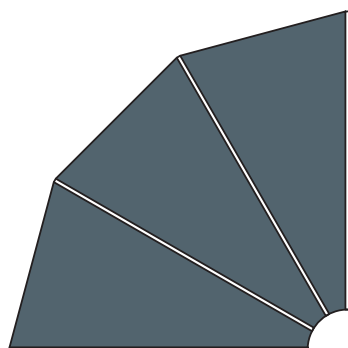

4 arches

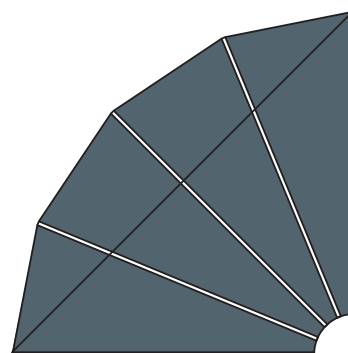

5 arches

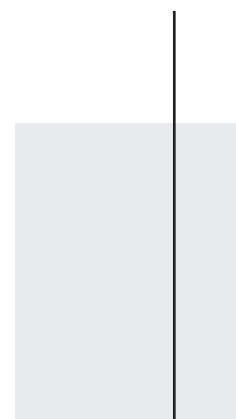



THE VALUE OF EXCLUSIVITY

To trust Saxun is to rely on the widest variety of systems, fabrics, accessories and home automation options on the market.

We are committed to absolute configurability, whereby the designer and the user can decide every detail in order to turn the acquired system into a unique piece that meets the needs of the space.

Because it's variety that makes the difference.

Kiara with lighting LEDs.

OPTIONAL UPGRADES

A NEW DIMENSION IN SOLAR PROTECTION

VALANCE AND SELVEDGE

The valance is a customisable extension for those seeking protection from horizontal sun rays.

With the selvedge, the user is protected from horizontal sun rays whenever appropriate and will have the option to assemble and disassemble it as needed. It is completely custom-made.

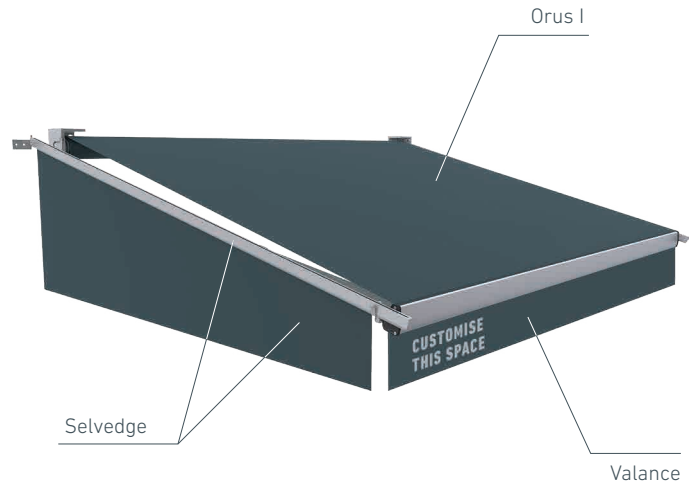

TYPES OF VALANCE:

Straight valance



Wavy valance



BOX TERMINAL

This system allows the installation of a height-adjustable canvas that can reach the floor and act to close the space.

Thanks to its compatibility, it is an ideal solution for those who want to give their awning more functionality.

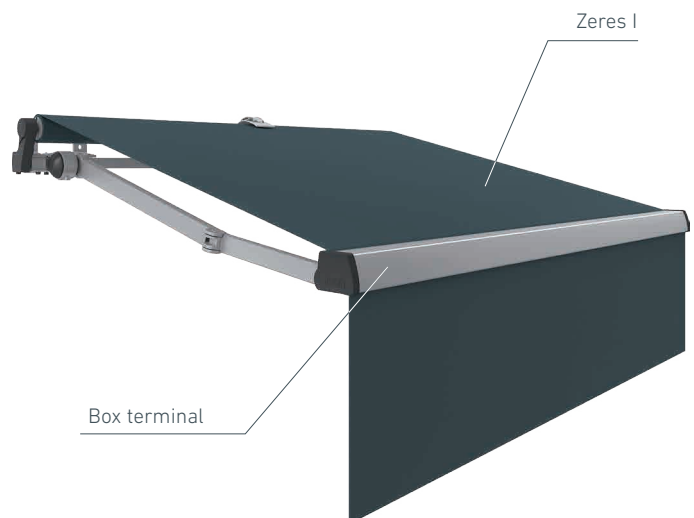

FULVIA SIDE ENCLOSURE

The side enclosure made of glass, PVC or canvas provides the space with extra protection.

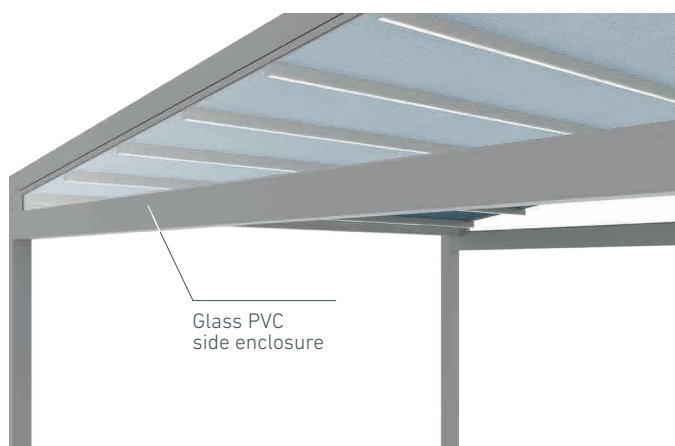

HALF-BOX TYPE

A system designed to protect the fabric, and to provide an extra aesthetic touch to those awnings that are not part of the box range.

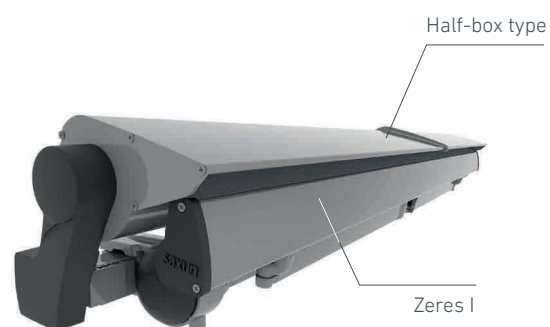

CANOPY

The aluminium protection on the awning is installed directly on the wall and protects the system from dirt and weather.

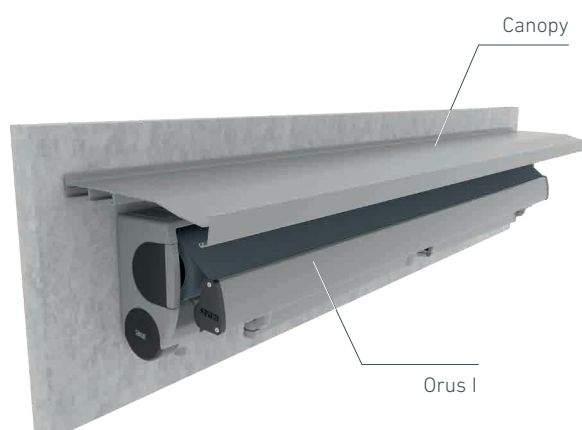

LED LIGHTING

The option to include 100% adjustable LED lighting in the awning arms guarantees users the ideal environment not only during the day, but also at night.

A solution for those who want to enjoy their terrace 24 hours a day.



COLOURS AND FINISHES

THE VALUE OF FREEDOM OF CHOICE

The colour of the awning structure complements the colour effect of the canvas and guarantees a match with the architecture of the house or business to be protected.

From different shades of white to colours inspired by the timeless elegance of anthracite, Saxun offers its customers a wide selection of shades in white, silver, RAL, anodised colours and wood veneers to suit the personal preferences of each user.

No matter which awning colour the customer chooses, Saxun offers the possibility to design the system required for each space not only on a technical level but also on an aesthetic level.

In addition, the multitude of finishes from which the customer can choose will ensure the exclusivity of the system. Satin, matt, textured and highly resistant options give colour maximum stability and prevent the appearance of the defects typically associated with the passage of time.



*Zeres I
Kiara
Slavia*

CANVAS COLLECTION

Our endless range of solar protection canvases is designed to offer solutions for when the best sun and heat protection is needed, for both indoor and outdoor spaces.

The variety of colours and designs provides an authentic decorative solution for all types of homes, taking solar protection to a new dimension that has never been explored before: the ability to create an emotional response from those who are enjoying the space while simultaneously maintaining incomparable visual comfort.

Options that are fully compatible with the most advanced protection systems on the market. Options guaranteed by Saxun.

ACRYLICS

The daily needs of each consumer require various different solutions adapted to each of the products.

That is why our range of colours, designs and textures, designed to guarantee maximum comfort, are adapted to the needs of architects and interior designers all over the world.

The mass pigmenting system ensures that the colour of the product remains intact despite the passage of time and its use outdoors.

PVC

The most useful property of PVC fabrics is that they are fully waterproof, so are able to withstand intense wind and rain.

They are particularly effective in wet environments, helping to make sure that indoor spaces are always kept dry.

SOLTIS

Soltis is a range of composite fabrics for both indoor and outdoor use.

Perforated, waterproof and even opaque, they provide visibility to the outside, protection against heat or total privacy, depending on the needs of each space or user.

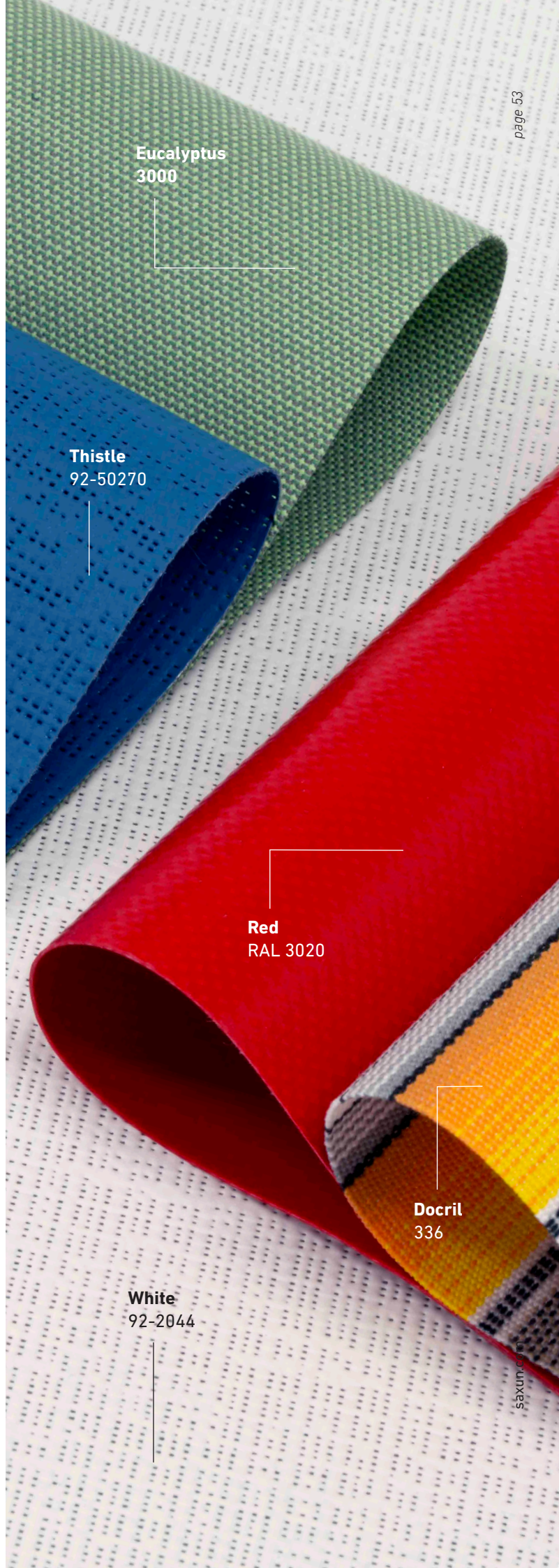

Eucalyptus
3000

Thistle
92-50270

Red
RAL 3020

Docril
336

White
92-2044

GREEN

by Sauleda & Pureti

THE FIRST EVER
FABRIC THAT
PURIFIES THE AIR

THE REVOLUTION OF HEALTHY SPACES

Fabrics treated with this finish, designed by Sauleda and Pureti, clean and purify the air via photocatalysis.

They reduce air pollutants such as NOx, SOx and VOCs. (volatile organic compounds).

This innovative finish reacts to UVA rays, facilitating a chemical process that purifies and oxygenates the air by absorbing carbon dioxide and transforming it into oxygen.

The GREEN surface is a long-lasting application that prevents dirt and pollution, saving time, money, water, chemicals and energy.



GREEN is a fabric that is coated with nanoparticles of titanium dioxide (TiO₂).

UVA rays hit the GREEN fabric, triggering a chemical process that converts atmospheric oxygen and water vapour into **OH and O₂ cleaning agents**.

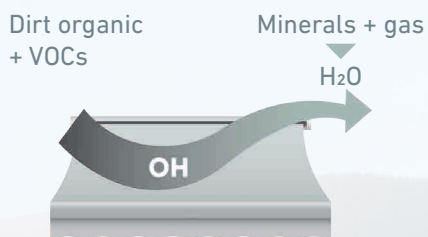

HO converts organic dirt and volatile organic compounds into minerals and gas and then converts back to H₂O.

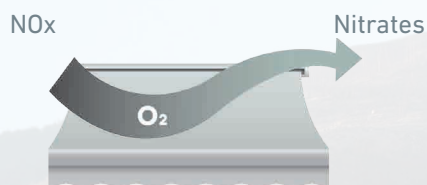

HO reduces nitrogen oxide (NO_x), one of the most harmful gases in the atmosphere, to relatively harmless nitrates.

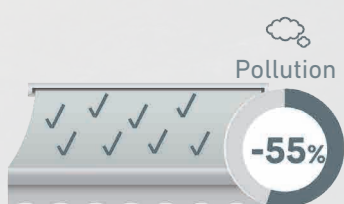

This process is repeated in order to clean the surface and the air, reducing nitrogen dioxide levels by about 55% in laboratory tests.

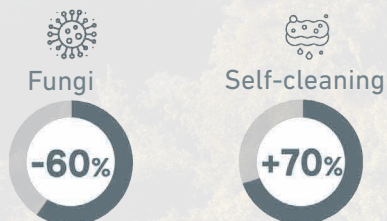

It reduces the presence of fungi by approximately 60%, and is self-cleaning with an effectiveness of approximately 70%.

MOTORISATION AND AUTOMATION

FREEDOM OF MOVEMENT FOR SMART AWNINGS

Saxun lets you reclaim the right to enjoy well-being at all times through customised automation that adjusts to the time of day and the weather situation.

Thanks to these automatic features, the user can regulate the solar protection of the awnings from a smartphone or tablet.

Optional rain and wind sensors ensure intelligent control of the system.

Because the smartest thing, in cases like this, is to enjoy yourself without having to worry about anything.





STATE-OF-THE-ART AUTOMATIC FEATURES

Thanks to the extensive network of sun, wind and rain sensors, Saxun's solar protection systems can react to any sudden change in the weather.

If the sun shines, the awning will automatically extend. If the wind speed accelerates or it rains, it will roll up instantly.



WIDE VARIETY OF DRIVE SYSTEMS

The touch of a button will ensure perfect protection from the sun, making the difference between perfect visibility and glare.

From multi-device remote controls to central controls or wall switches, Saxun always has the most convenient solution available to the user.



TAHOMA

THE FUTURE OF THE CONNECTED HOME

Saxun awnings are compatible with TaHoma, the intelligent system that allows control of many household appliances and systems through a single Internet connection. Wireless, safe and very easy to use.









































































CONNEXOON

HAVING A CONNECTED HOME IS VERY SIMPLE

Thanks to the Connexoon Terrace application and its home automation system, it only takes a smartphone to remotely control compatible awnings and lights and to view their operational status in real time.

CHARACTERISTICS OF THE SYSTEMS

		MAXIMUM DIMENSIONS		INCLINATION	MOTORISED		
		LINE / WIDTH (m)	CLEARANCE / HEIGHT (m)		MOTORISED	AUTOMATED	MANUAL
BOX	SLAVIA	5.00	2.50	0-69°			
	ELBA	6.00	3.50	0-72°			
	KIARA	6.00	4.00	0-75°			
	PALAS	7.00	3.60	0-40°			
	AMERIS	6.00	4.10	0-40°			
	AIDA	6.00	3.60	0-40°			
EXTENDIBLE ARMS	AURA	4.00	2.50	0-90°			
	ORUS I	6.00	3.50	0-85°			
	ORUS II	3.50	3.00	0-30°			
	HERTA	6.00	3.00	5-20°			
ARMS EXTENDIBLE MONOBLOCK	ZERES I	6.00	3.50	0-85°			
	ZERES II	3.50	3.00	0-30°			
FLAT AWNING	ANEAS	80x40	7.00	7.00			
		80x80	7.00	7.00			
		125x125	7.00	7.00			
DRAINPIPE AWNING	EROS	BLIND	5.00	3.25			
		SPIRE	5.00	3.25			
		LENS	5.00	3.25			
TENSIONED STRAIGHT-LINE AWNING	METIS	6.00	1.50	0-170°			
	HEBER	5.00	1.50	0-170°			
STOR AWNING	THEMIS	6.00	2.50	0-170°			
	HYBRIS	4.00	3.00	0-170°			
SRS	SRS	4.00	3.40				
VERANDA	JANA	5.00	5.00				
	LINA	5.00	4.00				
TAUT CANVAS PERGOLA	FULVIA	6.50	13.00				
CURTAIN AWNING	STRADA	7.00	4.00				
	MARTHA	2.50	3.00				
CAPOTA	LUTECIA	4 ARCHES	2.50	1.20			
		5 ARCHES	3.00	1.20			

INSTALLATION				CANVASES				EXTRAS				LED LIGHTING			IO TRANSMITTERS		IO AUTOMATIC FEATURES		HOME CONNECTED			
WINDOW	BALCONY	TERRACE	SLABS	STABILISED GLASS	ACRYLICS	PVC	SOLTIS	SCREEN	VALANCE	SIGNAGE	SELVEDGE	BOX TERMINAL	HALF-BOX	CANOPIE	BOX	ARMS	STICKS	TAHOMA	SECURITY CAMERA	CONEXXON		

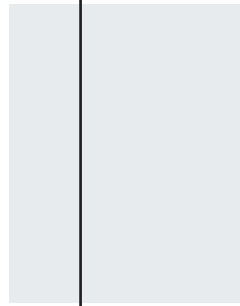

OTHER SOLUTIONS

BIOCLIMATIC PERGOLAS

ENJOY LIFE IN THE
OPEN AIR IN ANY
TIME OF YEAR

Saxun offers the opportunity to expand the living area of your home or business, with no need for any work.

Our pergolas are supported by their own structures and have various types of assemblies and configuration options.

A personalised solution is thereby created for every individual project, allowing for adoption of different shapes and sizes that can be adapted to different constructions.





Bioclimatic Pergola P-190



Dante Wind Screen

WIND SCREEN

DESIGN AND INNOVATION SERVING THE THINGS THAT MATTER

Our new Wind Screen are solar protection systems specially designed for outdoor installations, with a contemporary design that makes them the perfect solution when it comes to creating new environments and making the most of open spaces.

They help control brightness and glare in a variety of situations by attenuating light entering a building. A high-performance solution for controlling heat and light even in strong winds.

Its installation contributes significantly to greater comfort in all types of environments, achieving more productive surroundings.



Details of Dante Wind Screen

BESTA

THE SHADE THAT SUITS YOUR NEEDS

Besta is a new solar protection system developed by Saxun designed to add a touch of elegance and distinction to spaces that are exposed to sunlight.

It offers efficient protection against solar radiation, both for spaces in the residential sector and in the hotel and catering industry, thanks to the wide area of shade provided by its different configurations.



Besta Parasol



Besta Parasol with optional valance and mobile base with wheels

saxun[®]

Giménez Ganga, S.L.U.

Polígono Industrial El Castillo
C/ Roma, 4
03630 Sax (Alicante) España

t. (+34) 965 474 050 | 965 474 205
f. (+34) 965 474 563

info@saxun.com

saxun.com

